



Electrolux
PROFESSIONAL

Standard Preparation 1600 mm Wall Cupboard with 2 Sliding Doors

ITEM # _____

MODEL # _____

NAME # _____

SIS # _____

AIA # _____



132833 (PS1600LCN)

Wall Cupboard with 2 sliding doors, 1600mm

Short Form Specification

Item No. _____

Constructed in stainless steel. Back and bottom are made from a single bended stainless steel sheet for easier cleaning. Uprturned panel edges. Base shelf and height-adjustable intermediate shelf. Double-walled sliding doors. Loading capacity: 80kg.

Main Features

- Handles in stainless steel for better hygiene and reliability.
- Sturdiness, stability and reliability of table accurately tested.

Construction

- Wall cupboard features an ergonomic handle and an internal shelf which can be positioned at three different levels.
- Easy access to the cupboard interior on all lengths guaranteed by the use of only 2 doors.
- Two double-walled sliding doors flush fitting to the front of the frame can easily be removed without the use of tools to facilitate cleaning of the cupboard interior.
- Sturdy sound-deadened sliding doors on tracks located flush to the front of the frame.
- 100 mm upstand with 10 mm radiused corner and 13 mm deep, designed to be used against a wall.
- Scotch Brite finish to meet the highest hygiene standards.

Optional Accessories

- Lighting kit with led for wall cupboards (1000mm and 1200mm) PNC 850709
- Lighting kit with led for wall cupboards (1400mm, 1600mm and 1800mm) PNC 850710

APPROVAL: _____



Experience the Excellence
www.electroluxprofessional.com

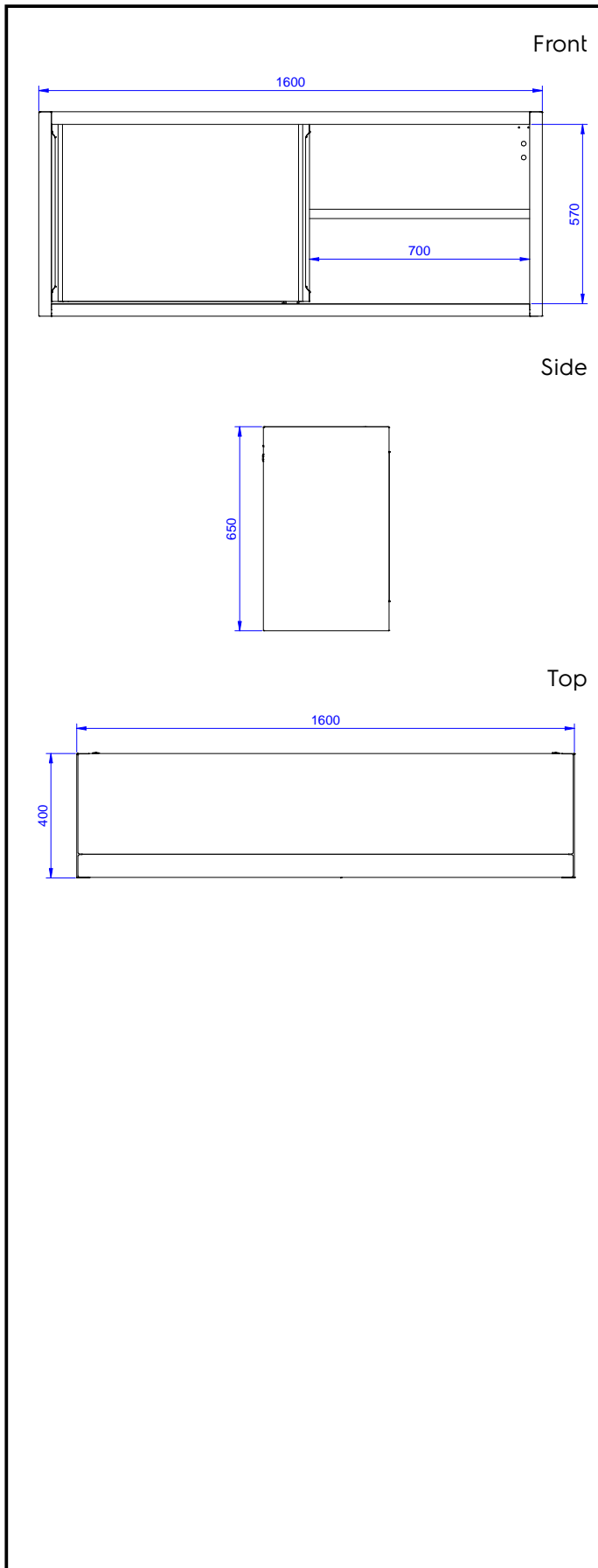

Key Information:

N° of doors:	2
132833 (PS1600LCN)	
External dimensions, Width:	1600 mm
External dimensions, Depth:	400 mm
External dimensions, Height:	650 mm